

Silicon Epitaxial Planar Transistor

S8550

FEATURES

- High Collector Current.($I_C = -500\text{mA}$)
- Complementary To S8050.
- Excellent H_{FE} Linearity.



APPLICATIONS

- High Collector Current.

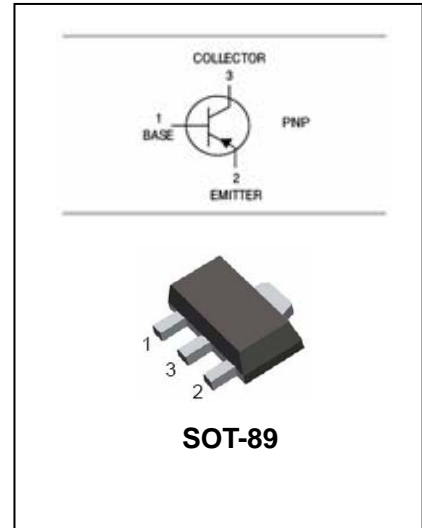

ORDERING INFORMATION

Type No.	Marking	Package Code
S8550	2TY	SOT-89

MAXIMUM RATING @ $T_a = 25^\circ\text{C}$ unless otherwise specified

Symbol	Parameter	Value	Units
V_{CBO}	Collector-Base Voltage	-40	V
V_{CEO}	Collector-Emitter Voltage	-25	V
V_{EBO}	Emitter-Base Voltage	-5	V
I_C	Collector Current -Continuous	-500	mA
P_C	Collector Dissipation	750	mW
T_j, T_{stg}	Junction and Storage Temperature	-55 to +150	$^\circ\text{C}$



Silicon Epitaxial Planar Transistor

S8550

ELECTRICAL CHARACTERISTICS @ Ta=25°C unless otherwise specified

Parameter	Symbol	Test conditions	MIN	MAX	UNIT
Collector-base breakdown voltage	$V_{(BR)CBO}$	$I_C=-100\mu A, I_E=0$	-40		V
Collector-emitter breakdown voltage	$V_{(BR)CEO}$	$I_C=-1mA, I_B=0$	-25		V
Emitter-base breakdown voltage	$V_{(BR)EBO}$	$I_E=-100\mu A, I_C=0$	-5		V
Collector cut-off current	I_{CBO}	$V_{CB}=-40V, I_E=0$		-0.1	μA
Collector cut-off current	I_{CEO}	$V_{CE}=-20V, I_B=0$		-0.1	μA
Emitter cut-off current	I_{EBO}	$V_{EB}=-3V, I_C=0$		-0.1	μA
DC current gain	h_{FE}	$V_{CE}=-1V, I_C=-50mA$	120	350	
		$V_{CE}=-1V, I_C=-500mA$	50		
Collector-emitter saturation voltage	$V_{CE(sat)}$	$I_C=-500mA, I_B=-50mA$		-0.6	V
Base-emitter saturation voltage	$V_{BE(sat)}$	$I_C=-500mA, I_B=-50mA$		-1.2	V
Transition frequency	f_T	$V_{CE}=-6V, I_C=-20mA$ $f=30MHz$	150		MHz

CLASSIFICATION OF $h_{FE(1)}$

Rank	L	H
Range	120-200	200-350

Silicon Epitaxial Planar Transistor

S8550

TYPICAL CHARACTERISTICS @ Ta=25°C unless otherwise specified

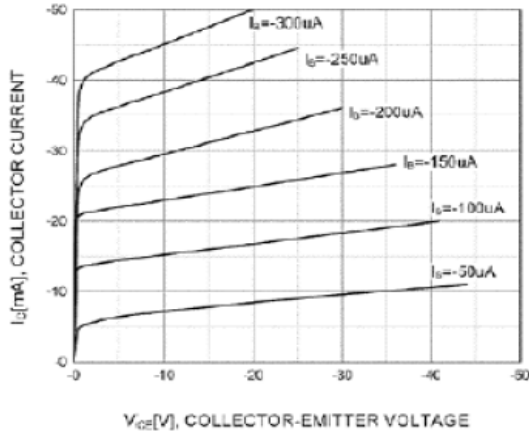

Static Characteristic

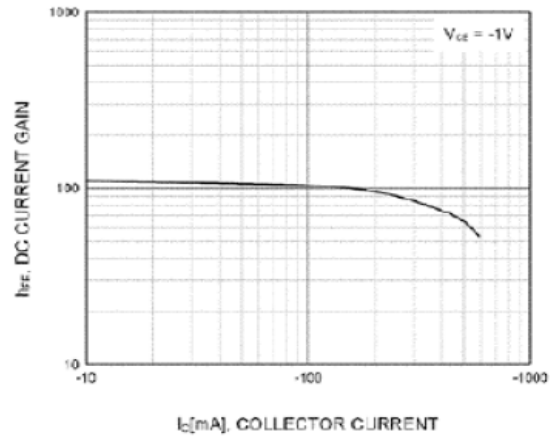

DC current Gain

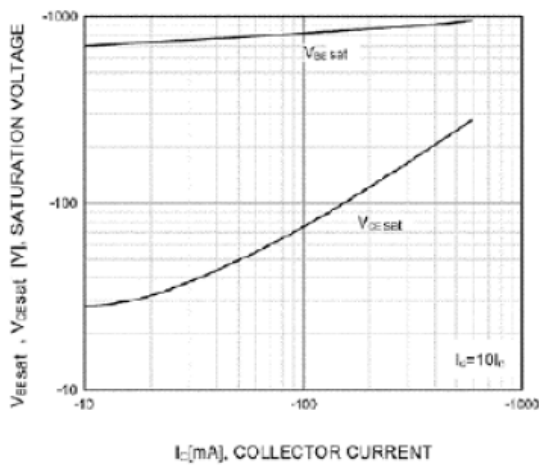

**Base-Emitter Saturation Voltage
Collector-Emitter Saturation Voltage**

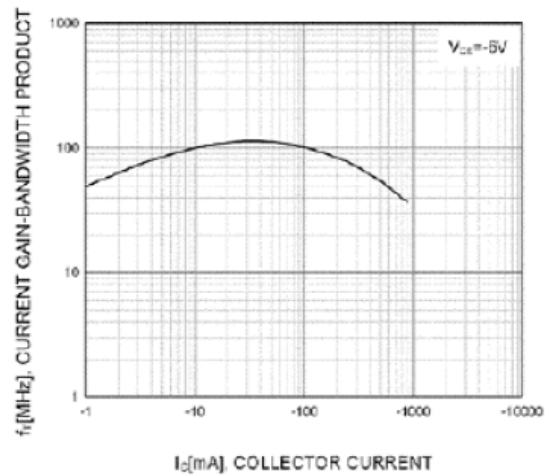

Current Gain Bandwidth Product



Silicon Epitaxial Planar Transistor

S8550

PACKAGE OUTLINE

Plastic surface mounted package

SOT-89

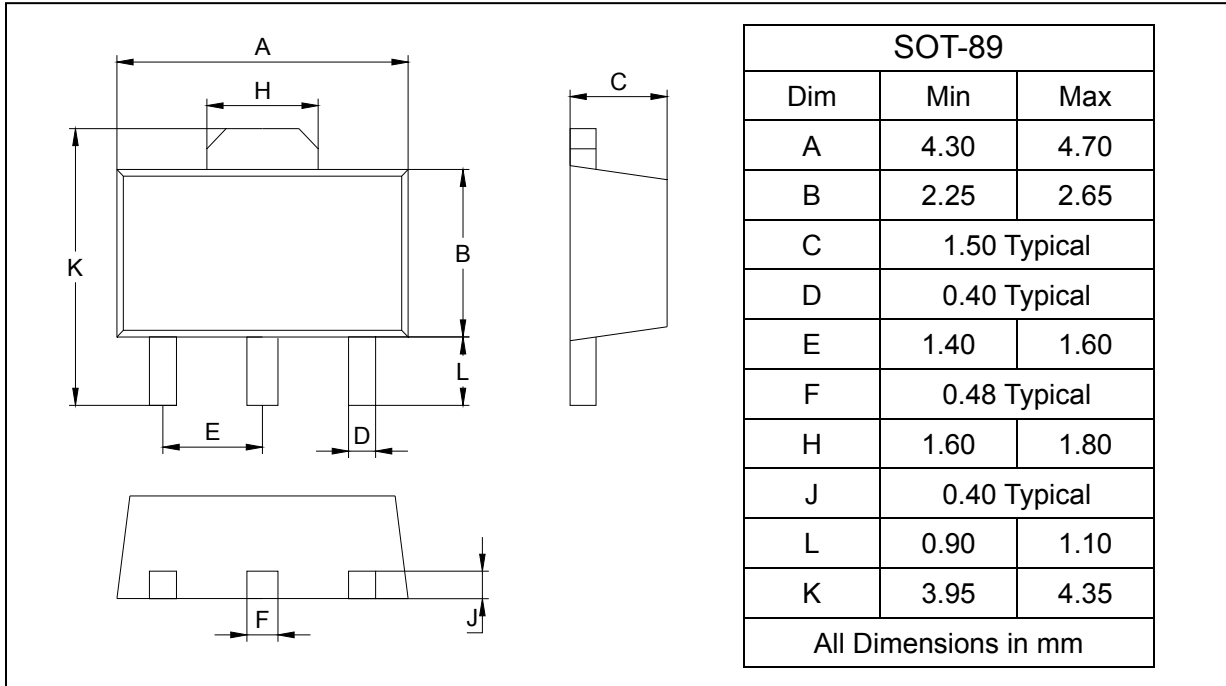

SOLDERING FOOTPRINT

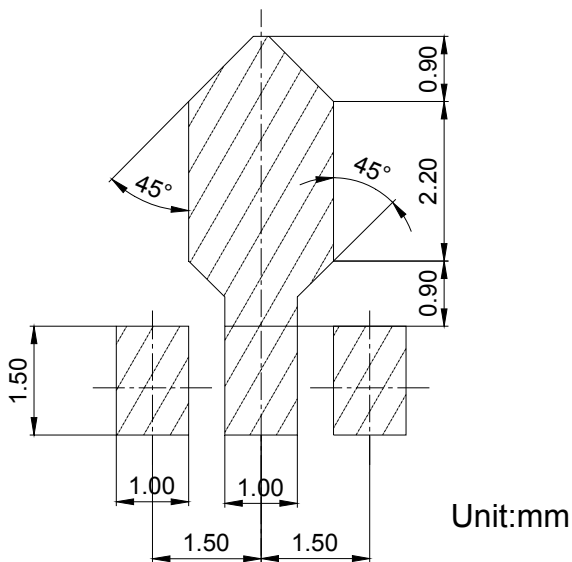

PACKAGE INFORMATION

Device	Package	Shipping
S8550	SOT-89	1000/Tape&Reel